

GPPO Surface Mounts

Catalog Number	A	B	C	D ϕ
B012-L13-01	FD	.140	.093	.012
B012-L15-01	SB	.140	.093	.012
B012-L13-02	FD	.052	.005	.012
B012-L15-02	SB	.052	.005	.012
B012-L13-03	FD	.047	-	-
B012-L15-03	SB	.047	-	-

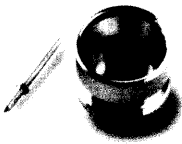
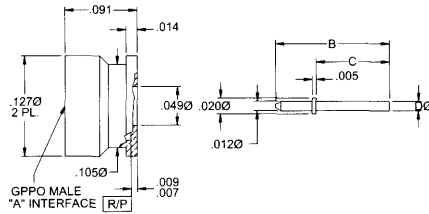

Male PCB Surface Mount
Sep c/c

Catalog Number	A
B012-P93-01	FD
B012-P95-01	SB

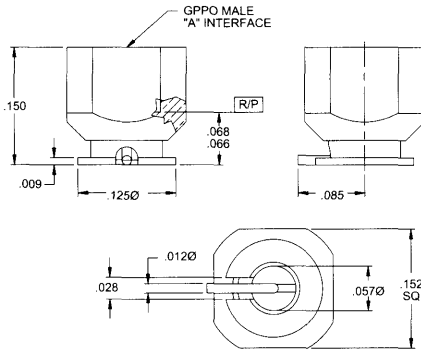

Male PCB Surface Mount

GPPO Cable Connectors

Catalog Number
B014-B11-01

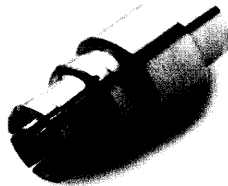
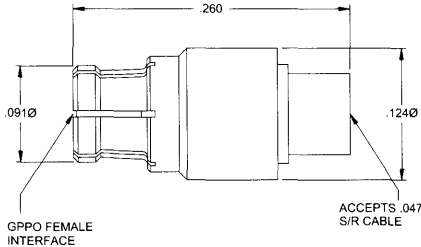

Female Cable Straight 0.047 S/R

Catalog Number
B014-D11-01

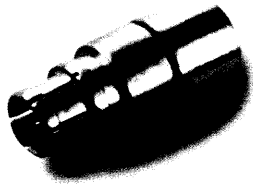
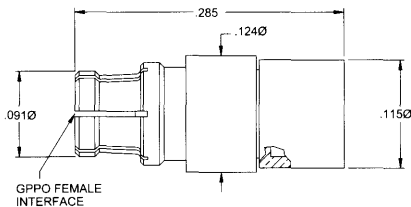

Female Cable Straight 0.086 S/R